

IMAGEWALL™

System Details

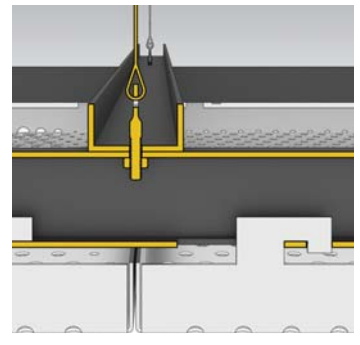

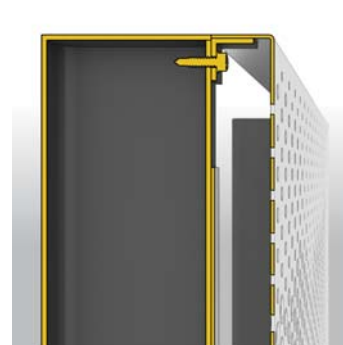
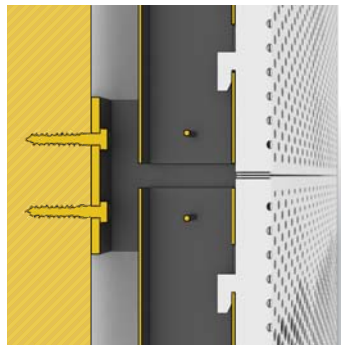
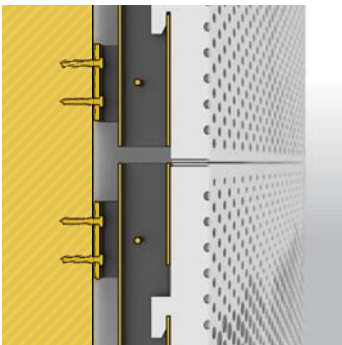
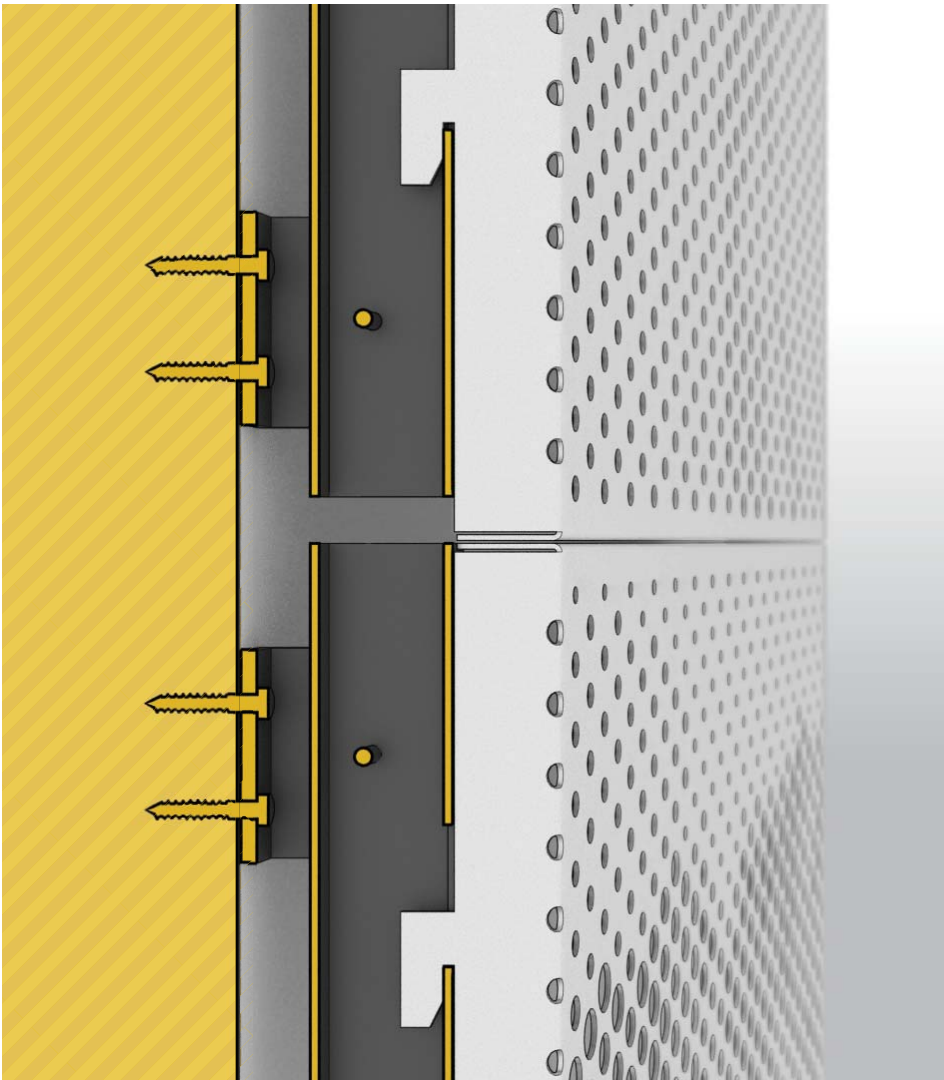

AECOM Reception | Photo by AECOM

WALL | MEDIUM

ImageWall's medium-duty wall system is used in interiors and on small exterior facades. Panels drop and lock into mullions, which are anchored to the wall with angle brackets. The brackets and mullions can vary in depth to allow extra space behind the panels for lighting.

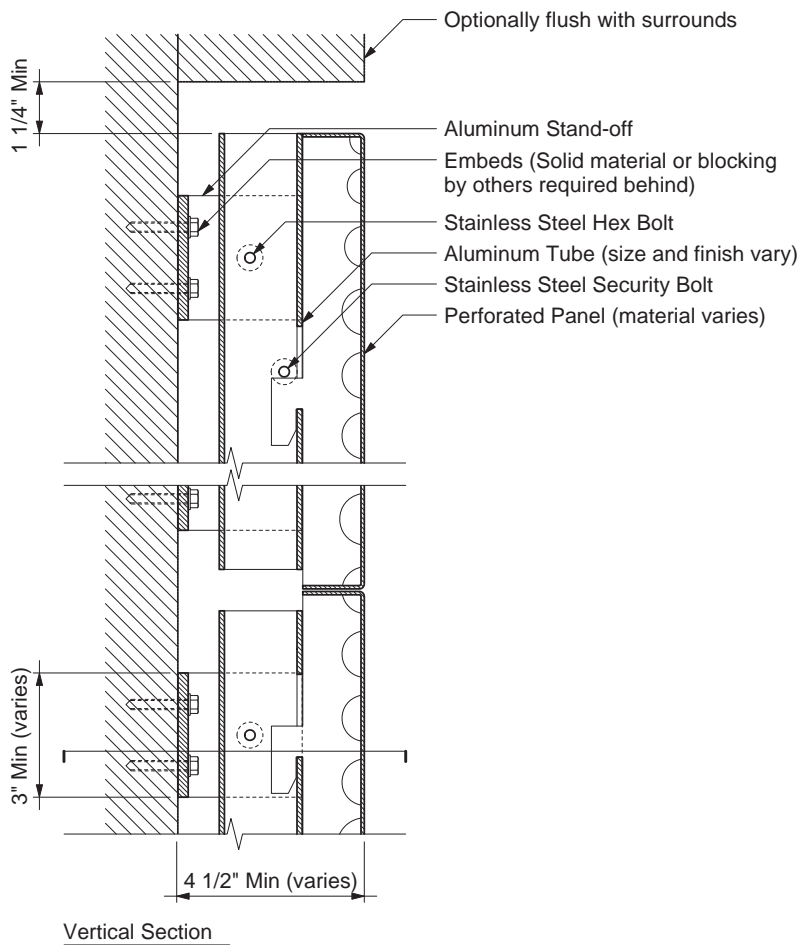
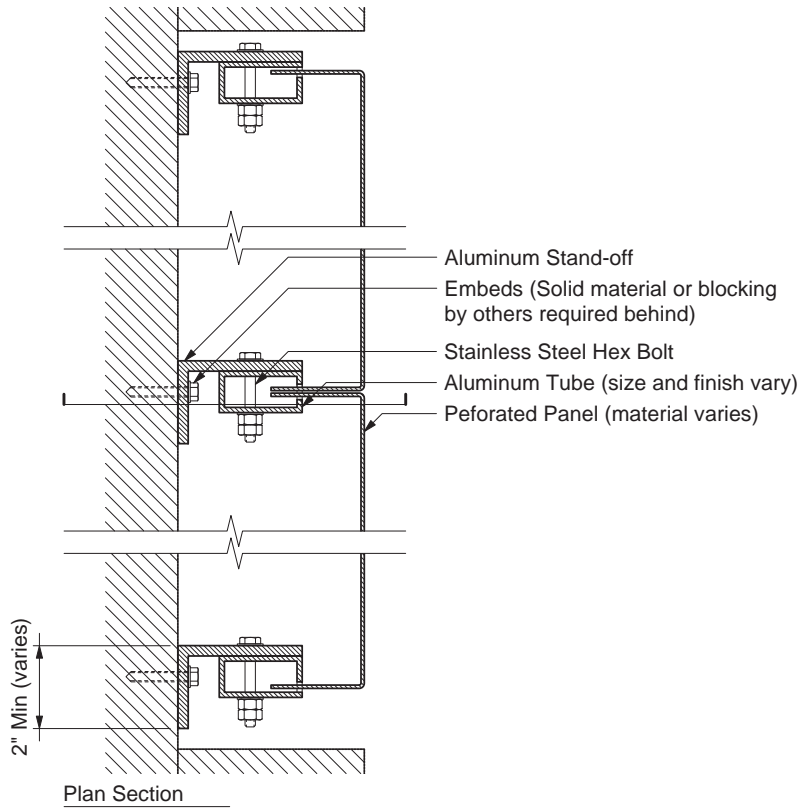

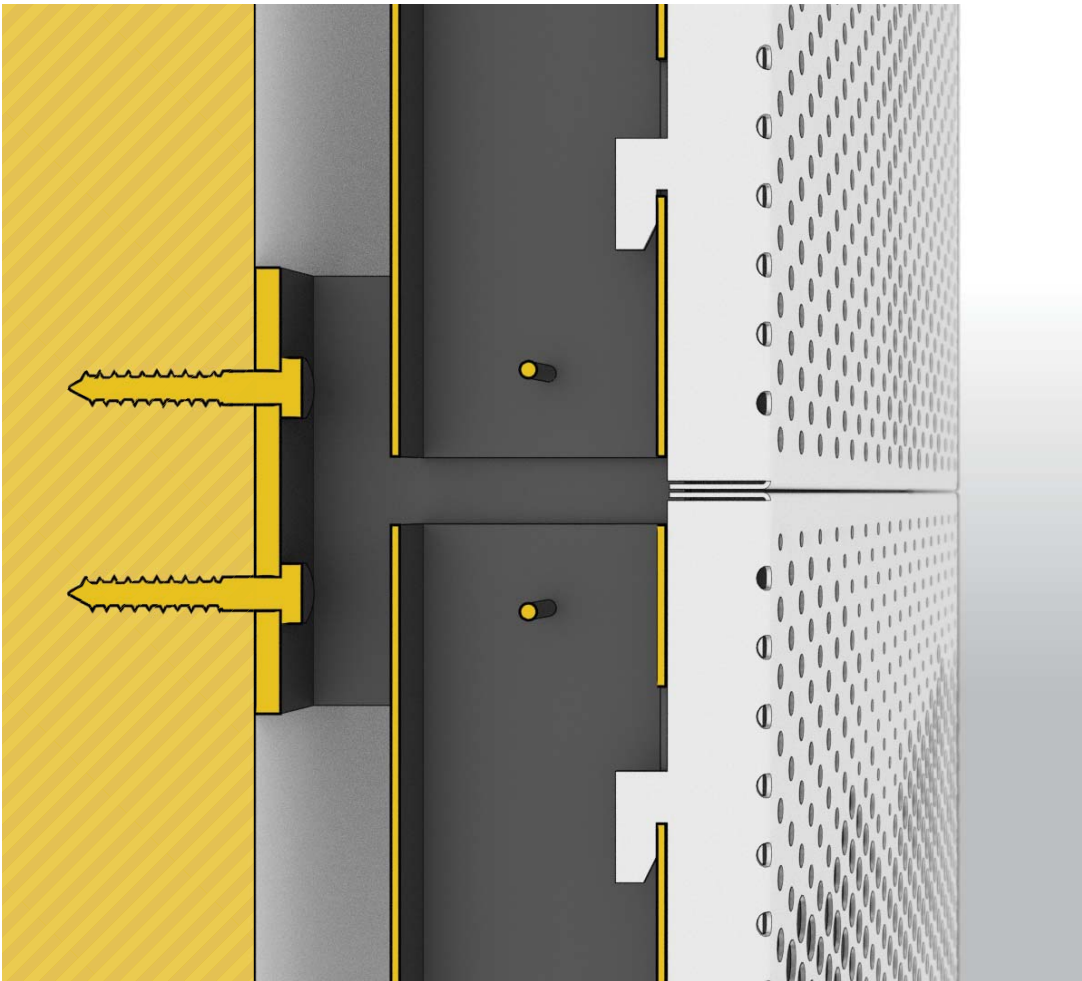

Blue Mesa Restaurant

WALL | HEAVY

ImageWall's heavy-duty wall system is used on medium to large-scale exterior facades. Panels drop and lock into mullions, which are attached to the wall with anchors. The anchors and mullions can vary in depth to allow extra space behind the panels for lighting.

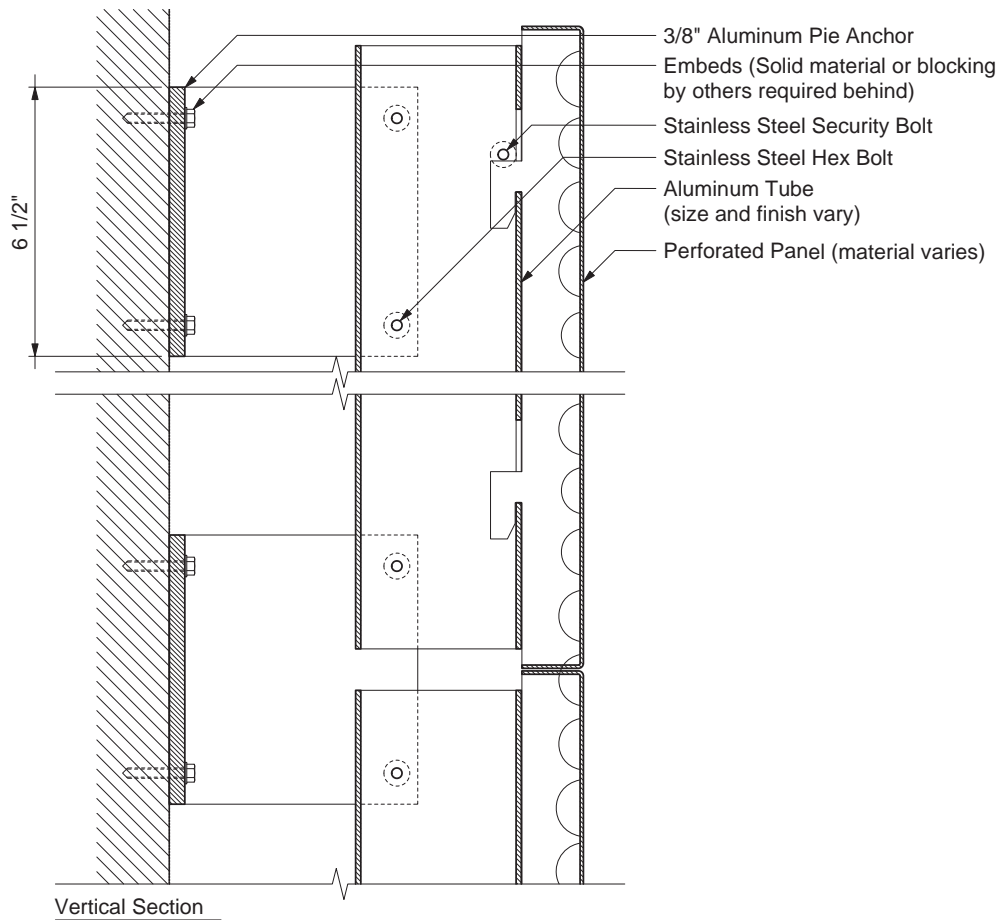
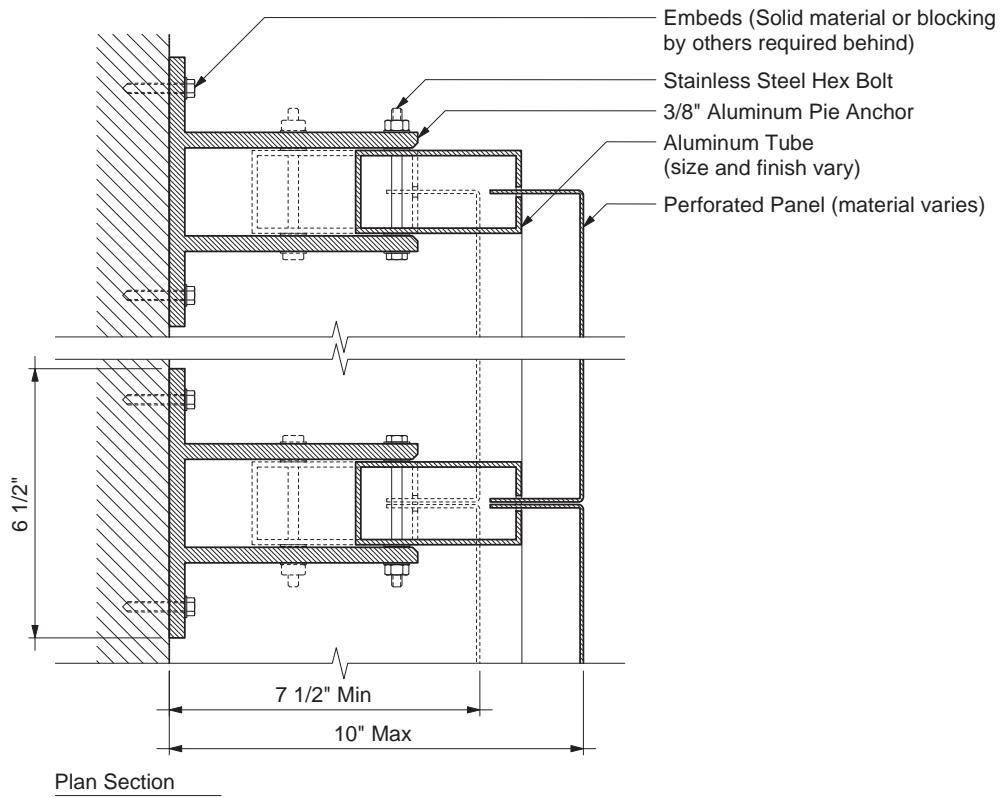

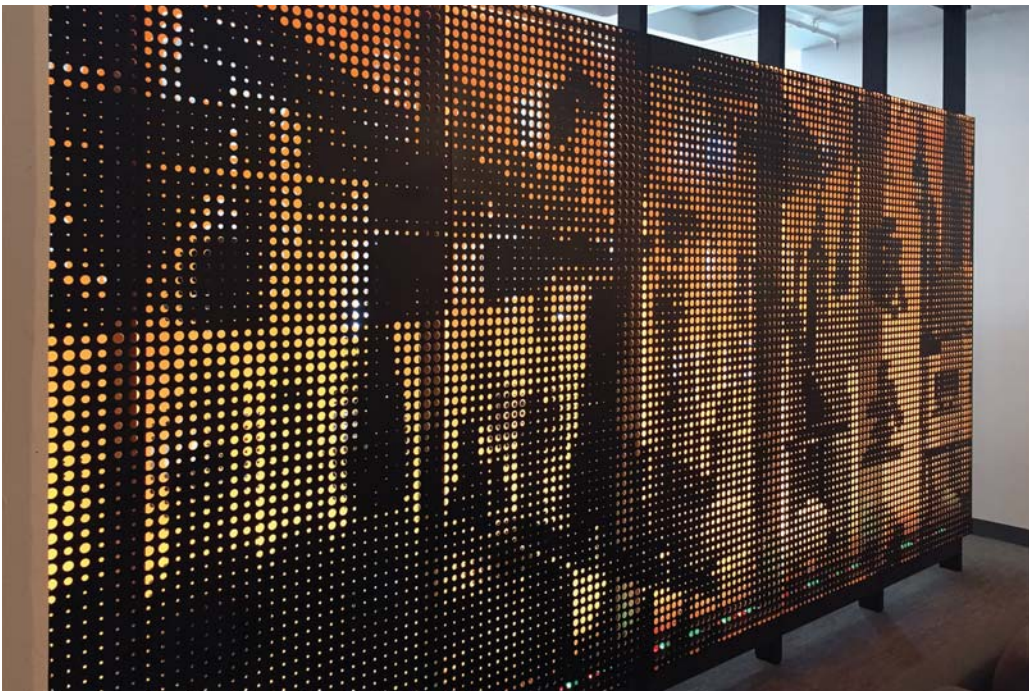
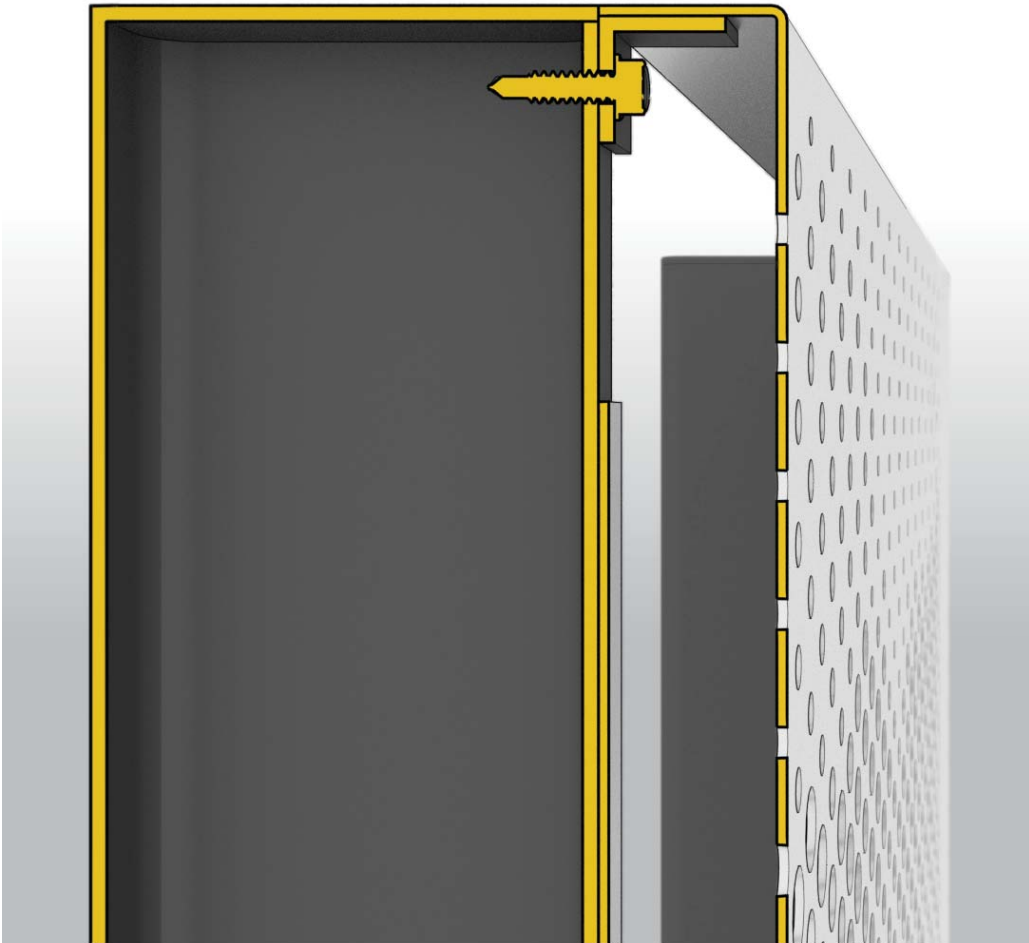

Twitter Headquarters

SCREEN

ImageWall's screen system can be used in a variety of settings to provide a free-standing structural backing for the panels. Panels are attached directly to vertical steel posts.

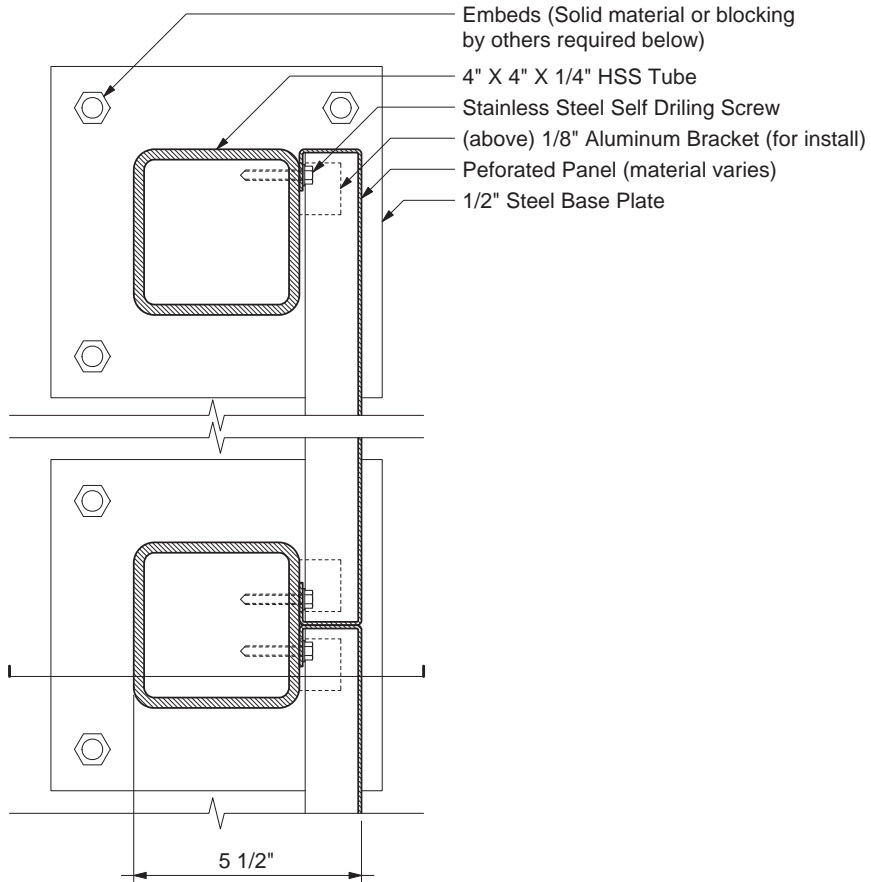

Plan Section

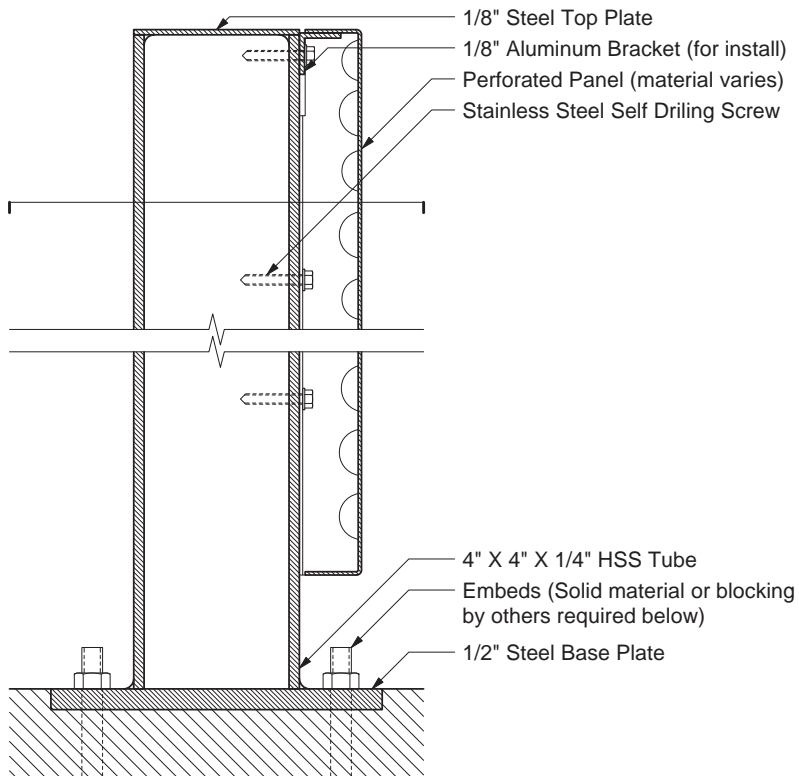

Vertical Section

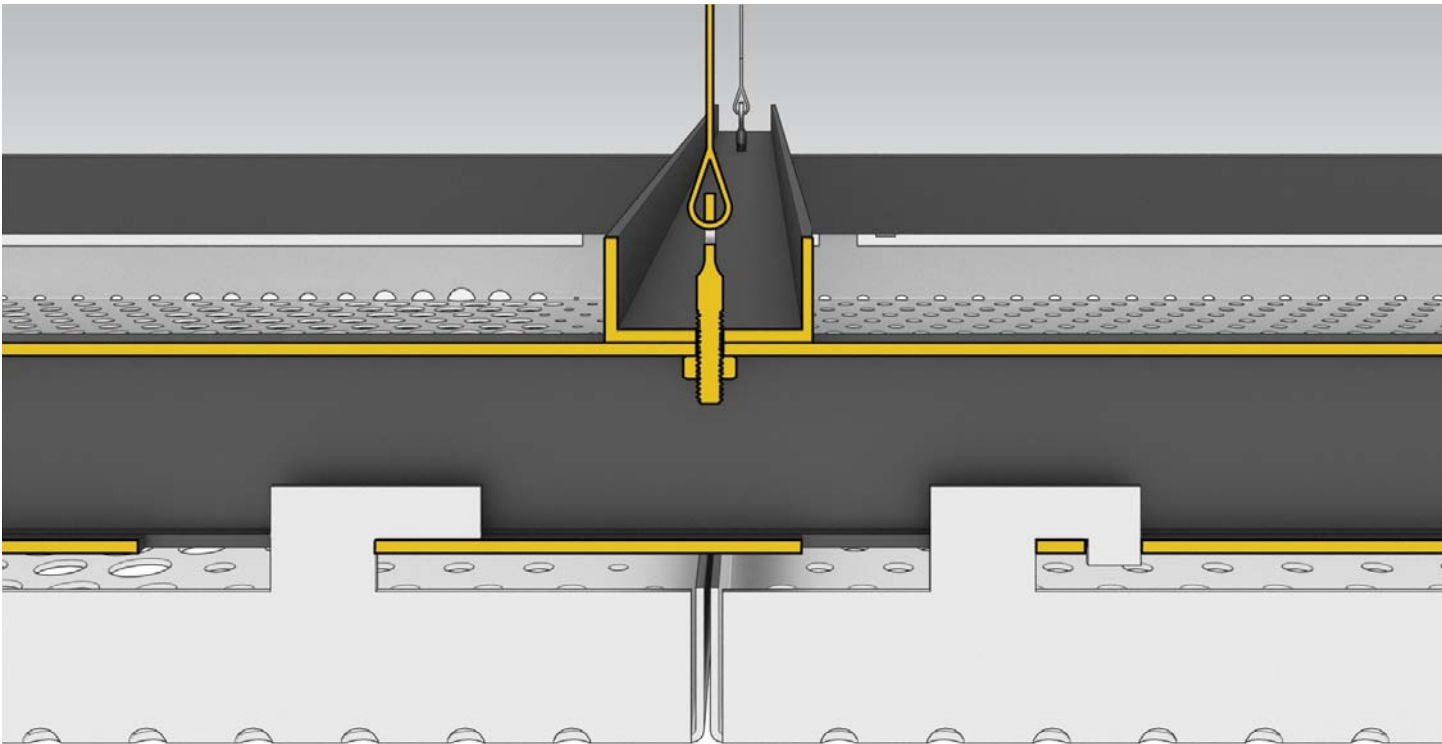

6060 NCX | Photo by Annie Devine

CEILING

ImageWall's ceiling system creates a drop-ceiling with a grid of panels. Panels slide and lock into a hanging structural grid created from mullions and C channels.

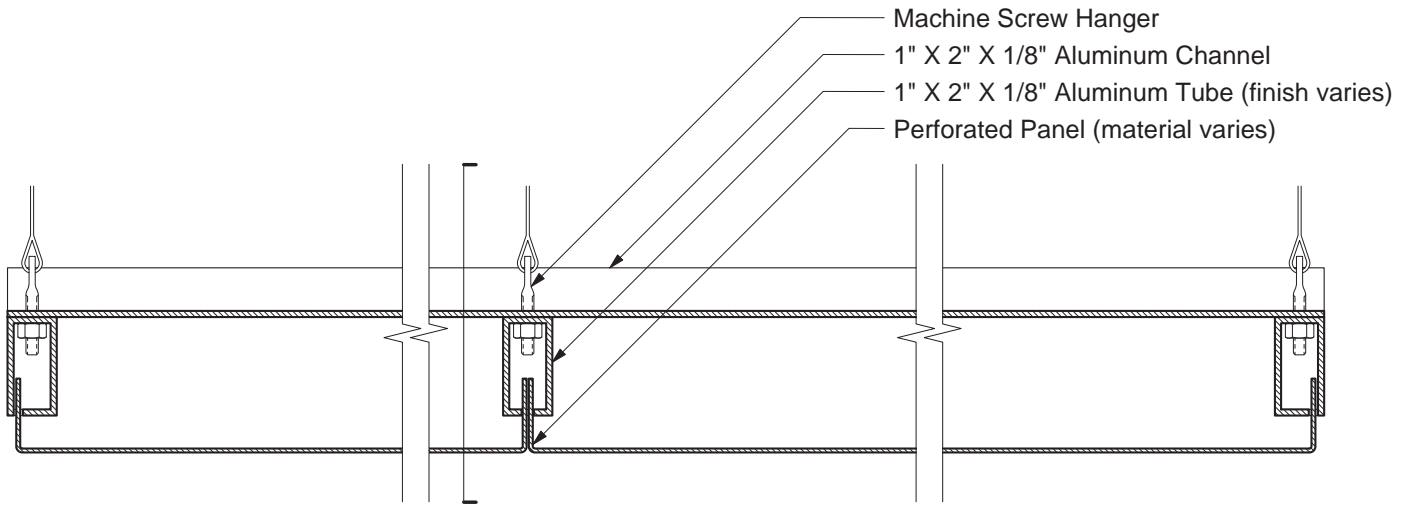

Transverse Section

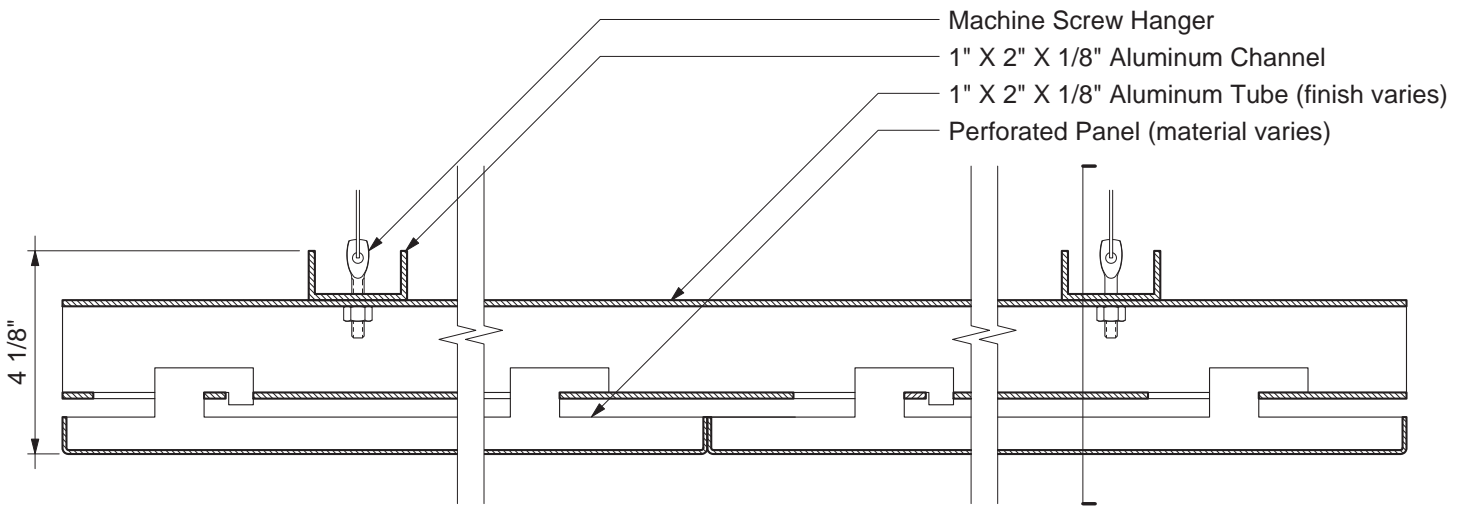

Longitudinal Section